

TOSHIBA

DVD PLAYER OWNER'S MANUAL

MODEL : SD-3815



Before connecting, operating or adjusting this product,
please read this instruction booklet carefully and completely.

Safety Precautions



CAUTION
RISK OF ELECTRIC SHOCK
DO NOT OPEN



CAUTION: TO REDUCE THE RISK OF ELECTRIC SHOCK DO NOT REMOVE COVER (OR BACK) NO USER-SERVICEABLE PARTS INSIDE REFER SERVICING TO QUALIFIED SERVICE PERSONNEL.



This lightning flash with arrowhead symbol within an equilateral triangle is intended to alert the user to the presence of uninsulated dangerous voltage within the product's enclosure that may be of sufficient magnitude to constitute a risk of electric shock to persons.



The exclamation point within an equilateral triangle is intended to alert the user to the presence of important operating and maintenance (servicing) instructions in the literature accompanying the appliance.

WARNING: TO REDUCE THE RISK OF FIRE OR ELECTRIC SHOCK, DO NOT EXPOSE THIS PRODUCT TO RAIN OR MOISTURE.

CAUTION: TO PREVENT ELECTRIC SHOCK, MATCH WIDE BLADE OF PLUG TO WIDE SLOT, FULLY INSERT.

ATTENTION: POUR ÉVITER LES CHOC ÉLECTRIQUES, INTRODUIRE LA LAME LA PLUS LARGE DE LA FICHE DANS LA BORNE CORRESPONDANTE DE LA PRISE ET POUSSER JUSQU'AU FOND.

WARNING: Do not install this equipment in a confined space such as a bookcase or similar unit.

CLASS 1 LASER PRODUCT
KLASSE 1 LASER PRODUKT
LUOKAN 1 LASER LAITE
KLASS 1 LASER APPARAT
CLASSE 1 PRODUIT LASER

CAUTION:

This Digital Video Disc Player employs a Laser System.

To ensure proper use of this product, please read this owner's manual carefully and retain for future reference, should the unit require maintenance, contact an authorized service location-see service procedure.

Use of controls, adjustments or the performance of procedures other than those specified herein may result in hazardous radiation exposure.

To prevent direct exposure to laser beam, do not try to open the enclosure. Visible laser radiation when open. DO NOT STARE INTO BEAM.

CAUTION: The apparatus shall not be exposed to water, dripping or splashing and that no objects filled with liquids, such as vases, shall be placed on the apparatus.

FCC WARNING: This equipment may generate or use radio frequency energy. Changes or modifications to this equipment may cause harmful interference unless the modifications are expressly approved in the instruction manual. The user could lose the authority to operate this equipment if an unauthorized change or modification is made.

REGULATORY INFORMATION: FCC Part 15

This product has been tested and found to comply with the limits for a Class B digital device, pursuant to Part 15 of the FCC Rules. These limits are designed to provide reasonable protection against harmful interference when the product is operated in a residential installation. This product generates, uses and can radiate radio frequency energy and, if not installed and used in accordance with the instruction manual, may cause harmful interference to radio communications. However, there is no guarantee that interference will not occur in a particular installation. If this product does cause harmful interference to radio or television reception, which can be determined by turning the product off and on, the user is encouraged to try to correct the interference by one or more of the following measures:

- Reorient or relocate the receiving antenna.
- Increase the separation between the product and receiver.
- Connect the product into an outlet on a circuit different from that to which the receiver is connected.
- Consult the dealer or an experienced radio/TV technician for help.



Notes on copyrights:

It is forbidden by law to copy, broadcast, show, broadcast via cable, play in public, or rent copyright material without permission.

This product is equipped with copy protection measures developed by Macrovision. Copy protection signals are recorded on some discs. When recording these discs on a VCR, picture noise will appear during playback.

This product incorporates copyright protection technology that is protected by certain U.S. patent claims and other intellectual property rights owned by Macrovision Corporation and other rights owners. Use of this copyright protection technology must be authorized by Macrovision Corporation, and is intended for home and other limited viewing uses only unless otherwise authorized by Macrovision Corporation. Reverse engineering or disassembly is prohibited.

SERIAL NUMBER: The serial number is found on the back of this unit. This number is unique to this unit and not available to others. You should record requested information here and retain this guide as a permanent record of your purchase.

Model No. _____

Serial No. _____

IMPORTANT SAFETY INSTRUCTIONS

CAUTION: PLEASE READ AND OBSERVE ALL WARNINGS AND INSTRUCTIONS IN THIS OWNER'S MANUAL AND THOSE MARKED ON THE UNIT. RETAIN THIS BOOKLET FOR FUTURE REFERENCE.

This set has been designed and manufactured to assure personal safety. Improper use can result in electric shock or fire hazard. The safeguards incorporated in this unit will protect you if you observe the following procedures for installation, use, and servicing.

This unit does not contain any parts that can be repaired by the user. **DO NOT REMOVE THE CABINET COVER, OR YOU MAY BE EXPOSED TO DANGEROUS VOLTAGE. REFER SERVICING TO QUALIFIED SERVICE PERSONNEL ONLY.**

- 1. Read These Instructions**
All safety and operating instructions should be read before the product is operated.
- 2. Follow All Instructions**
All operating and use instructions should be followed.
- 3. Keep These Instructions**
The safety and operating instructions should be retained for future reference.
- 4. Heed All Warnings**
All warnings on the product and in the operating instructions should be adhered to.
- 5. Power Sources**
This product should be operated only from the type of power source indicated on the marking label. If you are not sure of the type of power supply in your home, consult your product dealer or local power company. For products intended to operate from battery power, or other sources, refer to the operating instructions.
- 6. Grounding or Polarization**
Do not defeat the safety purpose of the polarized plug has two blades with one wider than the other. A grounding-type plug has two blades and a third grounding prong. The wide blade or the prong are provided for your safety. If the provided plug does not fit into your outlet, consult an electrician for replacement of the obsolete outlet.
- 7. Ventilation**
Slots and openings in the cabinet are provided for ventilation and to ensure reliable operation of the product and to protect it from overheating. These openings must not be blocked or covered. The openings should never be blocked by placing the product on a bed, sofa, rug or other similar surface. This product should not be placed in a built-in installation such as a bookcase or rack unless proper ventilation is provided or the manufacturer's instructions have been adhered to.
- 8. Heat**
Do not install near any heat sources such as radiators, heat registers, stoves, or other apparatus (including amplifiers) that produce heat.
- 9. Water and Moisture**
Do not use this apparatus near water. For example: near a bath tub, wash bowl, kitchen sink, Laundry tub, in a wet basement; or near a swimming pool.
- 10. Cleaning**
Unplug this product from the wall outlet before cleaning. Do not use liquid cleaners or aerosol cleaners. Clean only with dry cloth.
- 11. Power-Cord Protection**
Protect the power cord from being walked on or pinched particularly at plugs, convenience receptacles, and the point where they exit from the apparatus.
- 12. Overloading**
Do not overload wall outlets, extension cords, or integral convenience receptacles, this can result in a risk of fire or electric shock.
- 13. Lightning**
Unplug this apparatus apparatus during lightning storms or when unused for long periods of time. This will prevent damage to the product due to lightning and power-line surges.
- 14. Object and Liquid Entry**
Never push objects of any kind into this product through openings as they may touch dangerous voltage points or short-out parts that could result in a fire or electric shock. Never spill liquid of any kind on the product.

- 15. Attachments**
Only use attachments/accessories specified by the manufacturer.
- 16. Accessories**
Use only with the cart, stand, tripod, bracket, or table specified by the manufacturer or sold with the apparatus. When a cart is used, use caution when moving the cart/apparatus combination to avoid injury from tip-over.
- 17. Disc Tray**
Keep your fingers well clear of the disc tray as it is closing. It can cause personal injury.
- 18. Burden**
Do not place a heavy object on or step on the product. The object may fall, causing serious personal injury and serious damage to the product.
- 19. Connecting**
When you connect the product to other equipment, turn off the power and unplug all of the equipment from the wall outlet. Failure to do so may cause an electric shock and serious personal injury. Read the owner's manual of the other equipment carefully and follow the instructions when making any connections.
- 20. Sound Volume**
Reduce the volume to the minimum level before you turn on the product. Otherwise, sudden high volume sound may cause hearing or speaker damage.
- 21. Sound Distortion**
Do not allow the product to output distorted sound for a longtime. It may cause speaker overheating and fire.
- 22. Earphone**
When you use the earphone, keep the volume at a moderate level. If you use the earphone continuously with high volume sound, it may cause hearing damage.
- 23. Laser Beam**
Do not look into the opening of the disc tray or ventilation opening of the product to see the source of the laser beam. It may cause sight damage.
- 24. Disc**
Do not use a cracked, deformed, or repaired disc. These discs are easily broken and may cause serious personal injury and product malfunction.
- 25. Damage Requiring Service**
Refer all servicing to qualified service personnel. Servicing is required when the apparatus has been damaged in any way, such as power-supply cord or plug is damaged, liquid has been spilled or objects have fallen into the apparatus, the apparatus has been exposed to rain or moisture, does not operate normal, or has been dropped.
- 26. Servicing**
Do not attempt to service this product yourself as opening or removing the cover may expose you to dangerous voltage or other hazards. Refer all servicing to qualified service personnel.
- 27. Replacement parts**
When replacement parts are required, be sure the service technician has used replacement parts specified by the manufacturer or have the same characteristics as the original part. Unauthorized substitutions may result in fire, electric shock, or other hazards.
- 28. Safety Check**
Upon completion of any service or repairs to this product, ask the service technician to perform safety checks to determine that the product is in proper operating condition.



PORTABLE CART
WARNING

Table of Contents

Introduction

Safety Precautions	2
IMPORTANT SAFETY INSTRUCTIONS	3
Table of Contents	4
Before Use	5-6
Playable Discs	5
Precautions	6
Notes on Discs	6
About Symbols	6
Front Panel and Display Window	7
Remote Control	8
Rear Panel	9

Preparation

Connections	10-11
Connecting to a TV	10
Connecting to Optional Equipment	11
Before Operation	12-15
General Explanation	12
On-Screen Display	12
Initial Settings	13-15
• <i>Initial Settings General Operation</i>	13
• <i>Language</i>	13
• <i>Picture</i>	13
• <i>Sound</i>	14
• <i>Others</i>	14
• <i>Parental Control</i>	15

Operation

Operation with DVD, Video CD and Audio CD	16-19
Playing a DVD, Video CD and Audio CD	16
• Exchanging discs during playback	16
• Skipping discs	16
• Exchanging the disc and starting playback ..	16
General Features	17
• <i>Moving to another TITLE</i>	17
• <i>Moving to another CHAPTER/TRACK</i>	17
• <i>Still Picture and Frame-by-Frame Playback</i> ..	17
• <i>Pause</i>	17
• <i>Slow Motion</i>	17
• <i>Search</i>	17
• <i>Random</i>	17
• <i>Repeat</i>	18
• <i>Repeat A-B</i>	18
• <i>Time Search</i>	18
• <i>Selecting the sound enhancement</i>	18
• <i>Zoom</i>	18
• <i>Marker Search</i>	19
Special DVD Features	19
• <i>Title Menu</i>	19
• <i>Disc Menu</i>	19
• <i>Camera Angle</i>	19
• <i>Changing the Audio Language</i>	19
• <i>Changing the Audio Channel</i>	19
• <i>Subtitles</i>	19

Programmed Playback with Video CD

and Audio CD	20
Programmed Playback with Video CD and Audio CD	20
• <i>Repeat Programmed Tracks/All</i>	20
• <i>Erasing a Track from Program List</i>	20
• <i>Erasing the Complete Program List</i>	20
Operation with MP3 Disc	21
Playing an MP3 Disc	21
• <i>Pause</i>	21
• <i>Moving to another Track</i>	21
• <i>Repeat Track/All/Off</i>	21
Notes on MP3 Discs	21
Operation with JPEG Disc	22
Viewing a JPEG disc	22
• <i>Moving to another File</i>	22
• <i>Repeat All/Off</i>	22
Programmed Playback with MP3 or JPEG Disc ..	23
Programmed Playback with MP3 or JPEG Disc ..	23
• <i>Repeat Programmed Tracks/All/Off</i>	23
• <i>Repeat Programmed All/Off</i>	23
• <i>Erasing a Track/File from Program List</i> ..	23
• <i>Erasing the Complete Program List</i>	23
Additional Information	24
Last Condition Memory	24
Screen Saver	24
Video Mode Setting	24

Reference

Troubleshooting	25
Language Code List	26
Area Code List	27
Specifications	28

Others

LIMITED WARRANTY DVD VIDEO PLAYER . . . 29-30

About the symbols for instructions



Indicates hazards likely to cause harm to the unit itself or other material damage.





Indicates special operating features of this unit.



Indicates tips and hints for making the task easier.

Before Use

Playable Discs

	DVD Video (8 cm / 12 cm disc)
	Video CD (VCD) (8 cm / 12 cm disc)
	Audio CD (8 cm / 12 cm disc)

In addition, this unit can play a DVD-R, CD-R or CD-RW that contains audio titles, MP3 or JPEG files.

Notes

- Depending on the conditions of the recording equipment or the CD-R/RW disc itself, some CD-R/RW discs cannot be played on this unit.
- This unit cannot play CD-R/RW discs that do not contain any data, or contain different kinds of formatted data other than MP3 and CD-DA data.
- Do not attach any seal or label to either side (the labeled side or the recorded side) of a disc.
- Do not use irregularly shaped CDs (e.g., heart-shaped or octagonal). It may result in malfunctions.

Notes on DVDs and Video CDs

Some playback operations of DVDs and Video CDs may be intentionally fixed by software manufacturers. As this unit plays DVDs and Video CDs according to disc content designed by the software manufacturer, some playback features of the unit may not be available, or other functions may be added.

Refer also to the instructions supplied with the DVDs and Video CDs. Some DVDs made for business purposes may not be playable on this unit.

Regional code of the DVD player and DVDs

This DVD player is designed and manufactured for playback of region “1” encoded DVD software. The region code on the labels of some DVD discs indicates which type of player can play those discs. This unit can play only DVD discs labeled “1” or “ALL”. If you try to play any other discs, the message “Check Regional Code” will appear on the TV screen. Some DVD discs may not have a region code label even though their playback is prohibited by area limits.



Note on DTS-encoded CDs

To avoid possible damage to the audio system, turn down the volume before playing back such discs. Adjust the volume gradually to personal preference. To enjoy DTS Digital Surround™ playback, an external 5.1 channel DTS Digital Surround™ decoder system must be connected to the digital output of the player.

Disc-related terms

Title (DVD only)

The main film content or accompanying feature content or additional feature content, or music album.

Each title is assigned a title reference number enabling you to locate it easily.

Chapter (DVD only)

Sections of a picture or a musical piece that are smaller than titles.

A title is composed of one or several chapters. Each chapter is assigned a chapter number, enabling you to locate the chapter you want. Chapter numbers may not be recorded on all discs.

Track (Video CD and audio CD only)

Sections of a picture or a musical piece on a video CD or an audio CD. Each track is assigned a track number, enabling you to locate the track you want.

Scene

On a video CD with PBC (Playback control) functions, moving pictures and still pictures are divided into sections called “Scenes”. Each scene is displayed in the menu screen and assigned a scene number, enabling you to locate the scene you want.

A scene is composed of one or several tracks.

Types of video CDs

There are two types of video CDs:

Video CDs equipped with PBC (Version 2.0)

PBC (Playback control) functions allow you to interact with the system via menus, search functions, or other typical computer-like operations. Moreover, still pictures of high resolution can be played if they are included in the disc.

Video CDs not equipped with PBC (Version 1.1)

Operated in the same way as audio CDs, these discs allow playback of video pictures as well as sound, but they are not equipped with PBC.

Before Use (Cont'd)

Precautions

Handling the unit

When shipping the unit

The original shipping carton and packing materials come in handy. For maximum protection, re-pack the unit as it was originally packed at the factory.

When setting up the unit

The picture and sound of a nearby TV, VCR, or radio may be distorted during playback. In this case, position the unit away from the TV, VCR, or radio, and turn off the unit after removing the disc.

To keep the exterior surfaces clean

Do not use volatile liquids, such as insecticide spray, near the unit. Do not allow rubber or plastic products to contact the unit for a long period of time. They will leave marks on the surface.

To move the unit

When you move the player, take out any discs. If you don't, the discs may be damaged or drop into the internal workings of the DVD player.

Cleaning the unit

To clean the cabinet

Use a soft, dry cloth. If the surfaces are extremely dirty, use a soft cloth lightly moistened with a mild detergent solution. Do not use strong solvents, such as alcohol, benzene, or thinner, as these might damage the surface of the unit.

To obtain a clear picture

The DVD player is a high-tech, precision device. If the optical pick-up lens and disc drive parts are dirty or worn down, the picture quality will be poor. Regular inspection and maintenance are recommended after every 1,000 hours of use. (This depends on the operating environment.) For details, please contact your nearest dealer.

Notes on Discs

Handling discs

Do not touch the playback side of the disc. Hold the disc by the edges so that fingerprints will not get on the surface. Do not stick paper or tape on the disc.

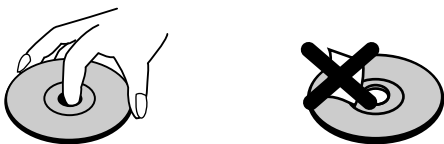

Storing discs

After playing, store the disc in its case. Do not expose the disc to direct sunlight or sources of heat, or leave it in a parked car exposed to direct sunlight, as there may be a considerable temperature build-up inside the car.

Cleaning discs

Fingerprints and dust on the disc can cause poor picture quality and sound distortion. Before playing, clean the disc with a clean cloth. Wipe the disc from the center out.

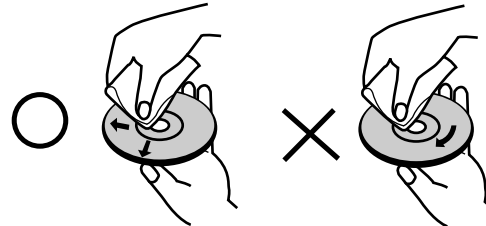

Do not use strong solvents such as alcohol, benzene, thinner, commercially available cleaners, or anti-static spray intended for older vinyl records.







About Symbols

About the symbol display

“” may appear on the TV screen during operation. This icon means the function explained in this owner's manual is not available on that specific DVD video disc.

About the disc symbols for instructions

When a section in this manual includes the following icons, the data provided herein is applicable only to the software represented by that icon.

	DVD
	Video CDs with the PBC (playback control) function.
	Video CDs without the PBC (playback control) function.
	Audio CDs.
	MP3 disc.
	JPEG disc.

Front Panel and Display Window

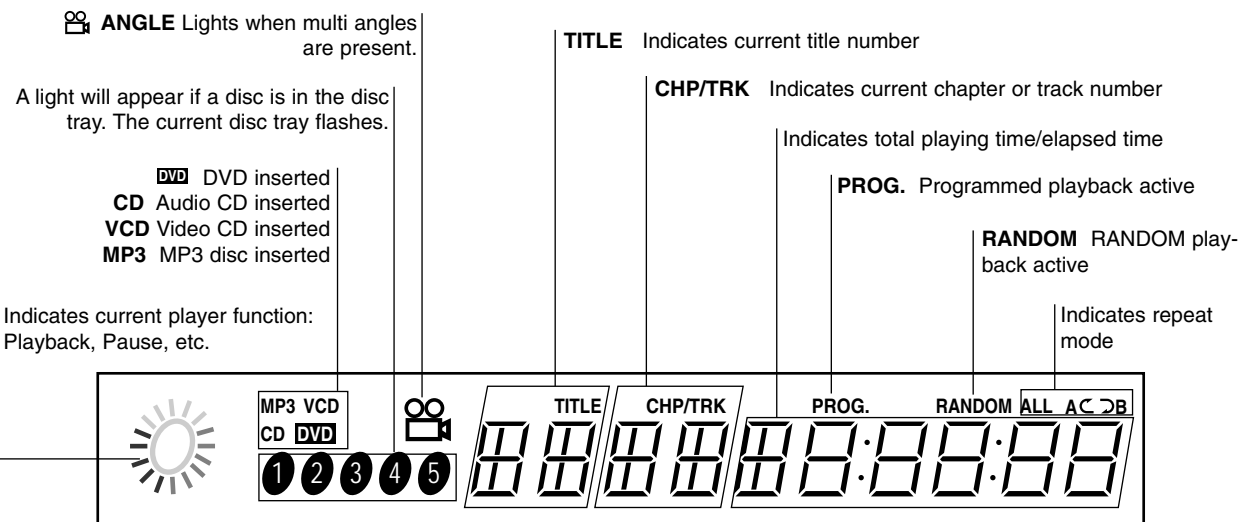
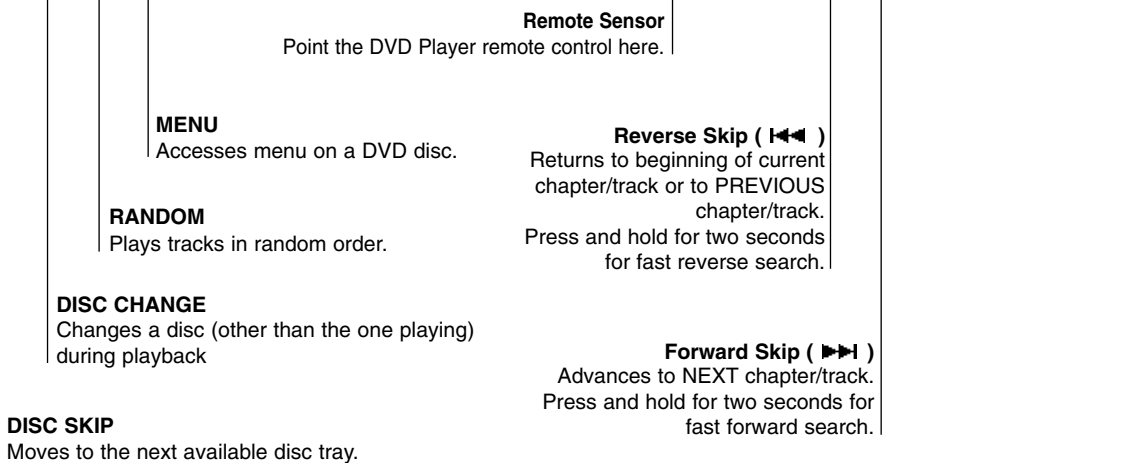
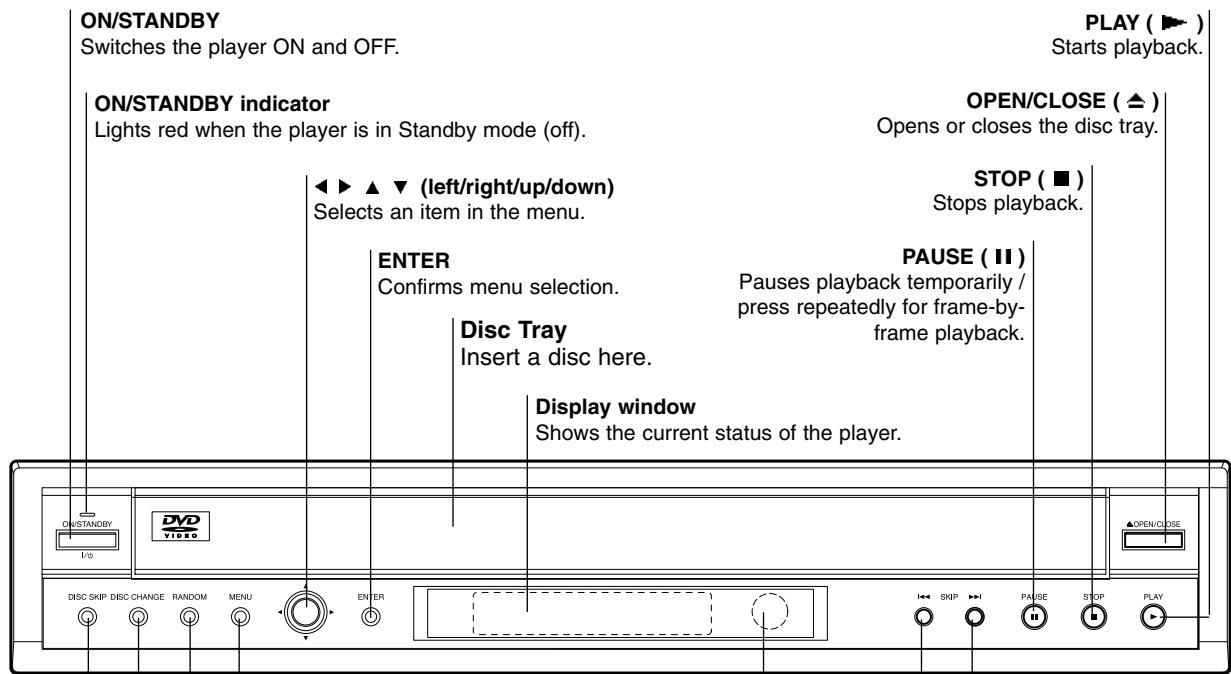

Remote Control

OPEN/CLOSE (▲)
Opens and closes the disc tray.

GUI DISPLAY
Accesses on-screen display

SETUP
Accesses or closes setup menu.

TOP MENU
Displays the Title menu of the disc if available.

◀ ▶ ▲ ▼ (left/right/up/down)
Selects an item in the menu.

CLEAR
Removes a track number on the program menu or a mark on the MARKER SEARCH menu.

PAUSE/STEP (II / II▶) •
Pauses playback temporarily / press repeatedly for frame-by-frame playback.

STOP (■) •
Stops playback.

Forward SKIP (▶▶) •
Advances to next chapter or track.

Reverse SKIP (◀◀) •
Returns to beginning of current chapter or track or go to previous chapter or track.

ANGLE •
Selects a DVD camera angle if available

SUBTITLE •
Selects a subtitle language.

AUDIO •
Selects an audio language (DVD) or an audio channel (CD).

FL DIM •
Controls the Display Window's light.

POWER
Switches DVD Player ON and OFF.

ZOOM
Enlarges video image.

E.A.M.
Selects sound mode during disc playback.

MENU
Accesses menu on a DVD disc.

ENTER
Confirms menu selection.

RETURN
- Removes the setup menu.
- Displays the menu of a video CD with PBC.

• Reverse SCAN (◀◀)
Search backward.

• PLAY (▶)
Starts playback.

• Forward SCAN (▶▶)
Search forward.

PROGRAM
Accesses or removes Program menu.

SEARCH
Displays MARKER SEARCH menu.

0-9 number buttons
Selects numbered items in a menu.

• Reverse SLOW (◀|)
Reverse slow playback.

• Forward SLOW (|▶)
Forward slow playback.

• DISC SKIP
Moves to the next available disc tray.

• RANDOM
Plays tracks in random order.

• MARKER
Marks any point during playback.

• REPEAT
Repeat chapter, track, title, all.

• A-B RPT
Repeat sequence.

Remote Control Operation Range

Point the remote control at the remote sensor and press the buttons.

- **Distance:** About 23 ft (7 m) from the front of the remote sensor
- **Angle:** About 30° in each direction of the front of the remote sensor

Remote control battery installation

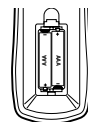

Detach the battery cover on the rear of the remote control, and insert two R03 (size AAA) batteries with ⊕ and ⊖ aligned correctly.



Caution
Do not mix old and new batteries. Never mix different types of batteries (standard, alkaline, etc.).

Rear Panel

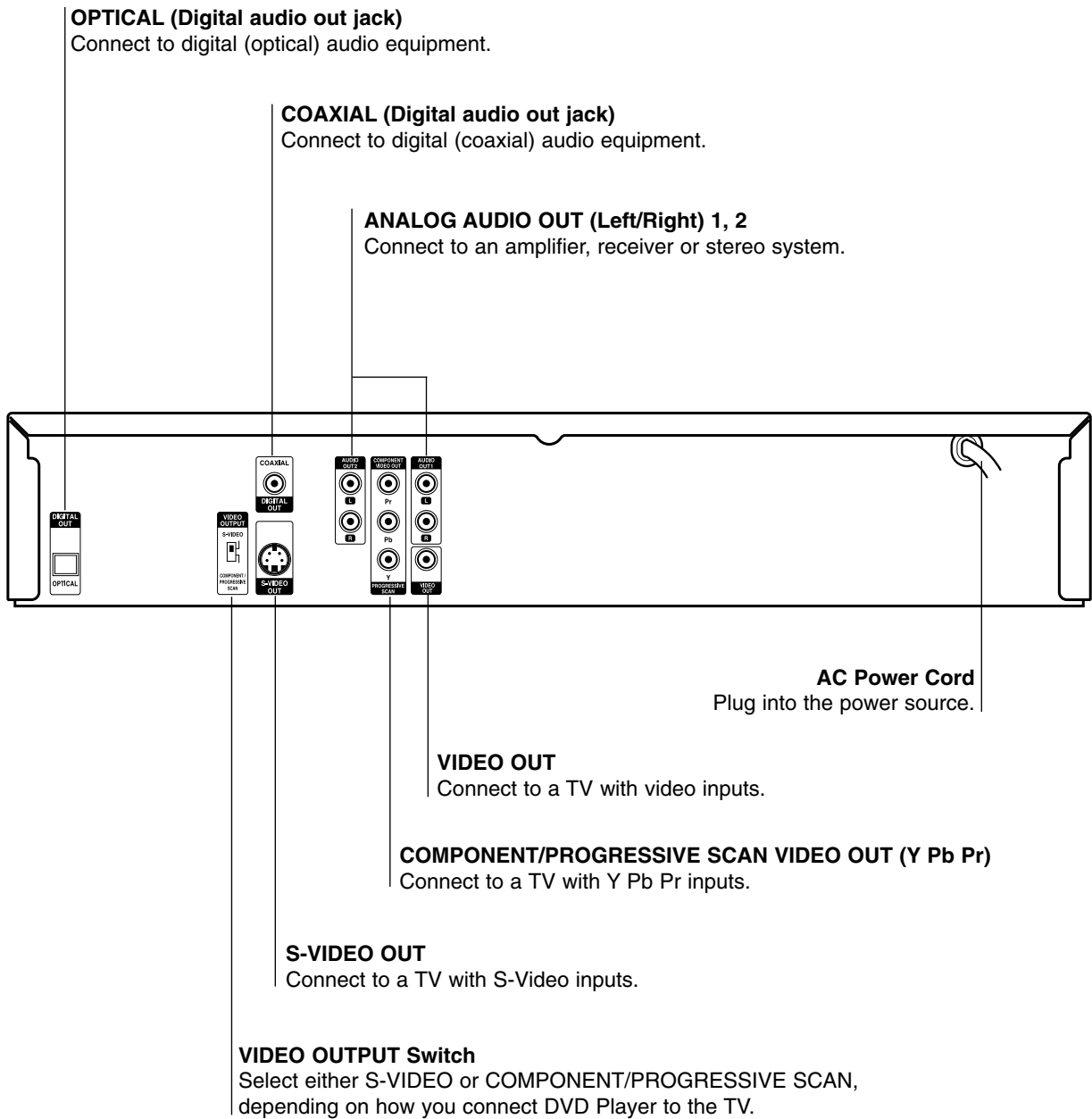

Do not touch the inner pins of the jacks on the rear panel. Electrostatic discharge may cause permanent damage to the unit.

Connections

Tips

- Depending on your TV and other equipment you wish to connect, there are various ways you could connect the player. Use only one of the connections described below.
- Please refer to the manuals of your TV, VCR, Stereo System or other devices as necessary to make the best connections.
- For better sound reproduction, connect the player's AUDIO OUT jacks to the audio in jacks of your amplifier, receiver, stereo or audio/video equipment. See "Connecting to optional equipment" on page 11.

Caution

- Make sure the DVD Player is connected directly to the TV. Select the TV to the corresponding video input.
- Do not connect the DVD Player's AUDIO OUT jack to the phono in jack (Turntable) of your audio system.
- Do not connect your DVD Player via your VCR. The DVD image could be distorted by the copy protection system.

Connecting to a TV

- Make one of the following connections, depending on the capabilities of your existing equipment.
- When using the COMPONENT VIDEO OUT/ PROGRESSIVE SCAN jacks, set the VIDEO OUTPUT switch to COMPONENT/PROGRESSIVE. When using the S-VIDEO OUT jack, set the VIDEO OUTPUT switch to S-VIDEO.

Video connection (Good)

- 1 Connect the VIDEO OUT jack on the DVD Player to the video in jack on the TV using the video cable supplied (V).
- 2 Connect the Left and Right AUDIO OUT jacks of the DVD Player to the audio left/right in jacks on the TV (A) using the supplied audio cables.

S-Video connection (Better)

- 1 Connect the S-VIDEO OUT jack on the DVD Player to the S-Video in jack on the TV using an optional S-Video cable (S).
- 2 Connect the Left and Right AUDIO OUT jacks of the DVD Player to the audio left/right in jacks on the TV (A) using the supplied audio cables.

Component Video (Color Stream®) connection (Best)

- 1 Connect the COMPONENT VIDEO OUT/ PROGRESSIVE SCAN jacks on the DVD Player to the corresponding in jacks on the TV using an optional Y Pb Pr cable (C).
- 2 Connect the Left and Right AUDIO OUT jacks of the DVD Player to the audio left/right in jacks on the TV (A) using the supplied audio cables.

Progressive Scan (ColorStream® pro) connection

- If your television is a high-definition or "digital ready" television, you may take advantage of the DVD Player's progressive scan output for the highest video resolution possible.
- If your TV does not accept the Progressive Scan format, the picture will appear scrambled if you select Progressive Scan output from the DVD Player.

- 1 Connect the COMPONENT VIDEO OUT/ PROGRESSIVE SCAN jacks on the DVD Player to the corresponding in jacks on the TV using an optional Y Pb Pr cable (C).
- 2 Connect the Left and Right AUDIO OUT jacks of the DVD Player to the audio left/right in jacks on the TV (A) using the supplied audio cables.

Notes

- Set the Progressive to "On" from the setup menu, see page 13.
- Progressive scan does not function simultaneously with the analog video connections (yellow VIDEO OUT jack).

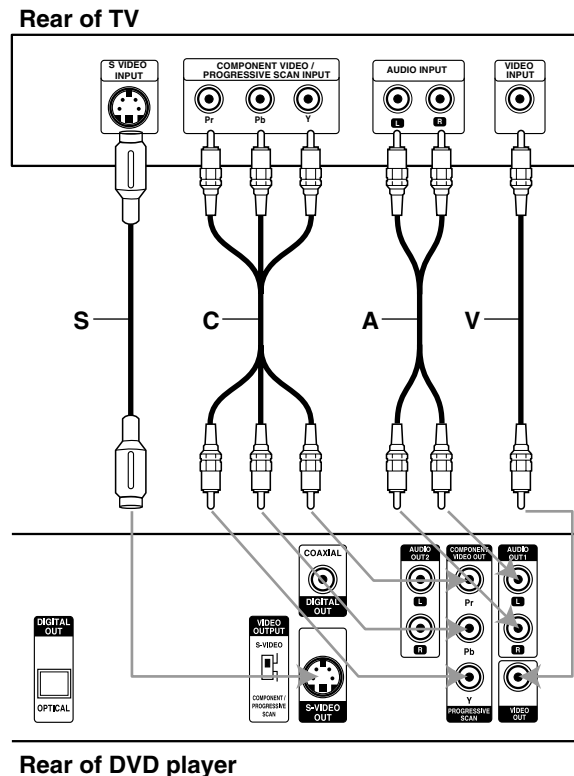

Note

If the TV has an S-video input, connect the DVD player with the S-video cable. When using an S-video cable, do not connect the yellow video cable.

Connections (Cont'd)

Connecting to Optional Equipment

Connecting to an amplifier equipped with two channel analog stereo or Dolby Surround

Connect the Left and Right AUDIO OUT jacks on the DVD Player to the audio left and right in jacks on your amplifier, receiver or stereo system, using the supplied audio cables (A).

Connecting to an amplifier equipped with two channel digital stereo (PCM) or to an Audio/Video receiver equipped with a multi-channel decoder (Dolby Digital™, MPEG 2 or DTS)

- 1 Connect one of the DVD Player's DIGITAL AUDIO OUT jacks (OPTICAL **O** or COAXIAL **X**) to the corresponding in jack on your amplifier. Use an optional digital (optical **O** or coaxial **X**) audio cable.
- 2 You will need to activate the player's digital output. (See "Digital Audio Output" on page 14).

T Digital Multi-channel sound

A digital multi-channel connection provides the best sound quality. For this you need a multi-channel Audio/Video receiver that supports one or more of the audio formats supported by your DVD Player (MPEG 2, Dolby Digital and DTS). Check the receiver manual and the logos on the front of the receiver.

N Notes

- If the audio format of the digital output does not match the capabilities of your receiver, the receiver will produce a strong, distorted sound or no sound at all.
- Six Channel Digital Surround Sound can only be obtained if your receiver is equipped with a Digital Multi-channel surround sound decoder.
- To confirm the audio format of the current DVD selection display, press AUDIO.
- Repeated pressing of the AUDIO button may allow you to select between various audio formats available on the disc.

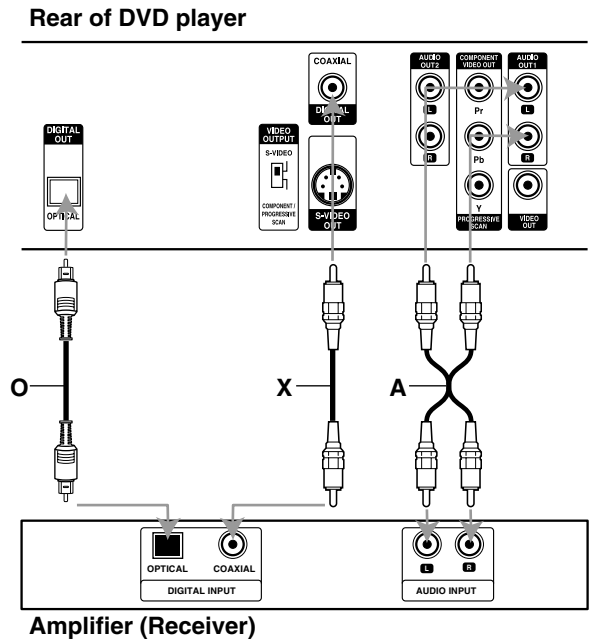

N Note

This player does not perform internal (2 channel) decoding of a DTS sound track. To enjoy DTS multi channel surround, you must connect this player to a DTS compatible receiver via one of this player's digital audio outputs.

Before Operation

General Explanation

This manual gives basic instructions for operating the DVD Player. Some DVDs require specific operation or allow only limited operation during playback. When this occurs, the symbol  appears on the TV screen, indicating that the operation is not permitted by the DVD Player or is not available on the disc.









On-Screen Display

General playback status can be displayed on the TV screen. Some items can be changed on the menu.

On-screen display operation

- 1** Press GUI DISPLAY during playback.
- 2** Press **▲** or **▼** to select an item.
The selected item will be highlighted.
- 3** Press **◀** or **▶** to change the setting of an item.
The number buttons can be also be used for setting numbers (e.g., title number). For some functions, press ENTER to execute the setting.







Repeat mode Icons

-  Repeat Title
-  Repeat Chapter
-  Repeat Track (non-PBC Video CDs and Audio CD only)
-  Repeat Current Disc (non-PBC Video CDs and Audio CD only)
-  Repeat All Discs (non-PBC Video CDs and Audio CD only)
-  Repeat A-B
-  Repeat Off
-  Resume play from this point
-  Action prohibited or not available

Notes

- Some discs may not provide all of the features included on the on-screen display example shown below.
- If no button is pressed for 10 seconds, the on-screen display disappears.





DVD

Items		Function (Press ▲/▼ to select desired item)	Selection Method
Title Number	 1/3	Displays the current title number and total number of available titles, and skips to a desired title number.	◀ / ▶, or Numbers, ENTER
Chapter Number	 1/12	Displays the current chapter number and total number of available chapters, and skips to a desired chapter number.	◀ / ▶, or Numbers, ENTER
Time search	 0:16:57	Displays the elapsed playing time, and searches a point identified by its elapsed time.	Numbers, ENTER
Audio language and Digital Audio Output mode	 1 ENG □□□□ 6 CH	Displays the current audio soundtrack language, encoding method and channel number, and any changes you make to the setting.	◀ / ▶
Subtitle language	 OFF	Displays the current subtitles language, and any changes you make to the setting.	◀ / ▶
Angle	 1/1	Displays the current angle number and total number of angles, and any changes you make to the angle number.	◀ / ▶
Sound	 NORM.	Displays the current sound mode, and any changes you make to the setting.	◀ / ▶

VCD2.0

VCD1.1

CD

Items		Function (Press ▲/▼ to select desired item)	Selection Method
Track Number	 1/4	Displays the current track number, total number of tracks and PBC On mode, and skips to the desired track number.	◀ / ▶, or Numbers, ENTER
Time	 0:16:57	Displays the elapsed playing time (Display only)	-
Audio Channel	 STER.	Displays the audio channel, and changes you make to the audio channel.	◀ / ▶
Sound	 NORM.	Displays the current sound mode, and any changes you make to the setting.	◀ / ▶

Before Operation (Cont'd)

Initial Settings

You can install your own Personal Preferences.

Initial Settings General Operation

- 1 Press SETUP.**
The setup menu appears.



- 2 Press ▲/▼ to select the desired item.**
The screen will display the current setting for the selected item, as well as alternate setting(s).
- 3 While the desired item is displayed, press ►, then ▲/▼ to select the desired setting.**
- 4 Press ENTER to confirm your selection.**
Some items require additional steps.
- 5 Press SETUP, RETURN or PLAY to exit the setup menu.**
If you press SETUP or RETURN to exit the setup menu, DVD Player will be in stop mode. So, you must press PLAY to play back.

Language

Disc Language **DVD**

Select a language for the disc's Menu, Audio and Subtitle.
Original : The original language included on the disc is selected.
Other : To select another language, enter the 4-digit number corresponding to the language code list on page 26. If you enter the wrong language code, press CLEAR.



Menu Language

Select a language for the setup menu. This is the menu you see when you press SETUP.



Picture

TV Aspect **DVD**

- 4:3 Letterbox**: Select when a standard 4:3 TV is connected. Displays theatrical images with masking bars above and below the picture.
- 4:3 Panscan**: Select when a standard 4:3 TV is connected. Displays pictures cropped to fill your TV screen. Both side of the original picture may be cut off.
- 16:9 Wide**: Select when a 16:9 wide TV is connected.

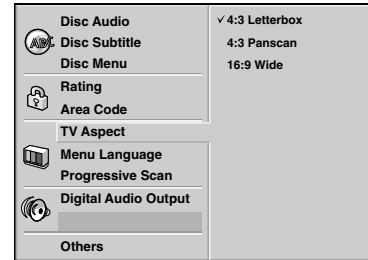

Progressive Scan **DVD**

Progressive Scan Video provides the highest resolution pictures with less flicker and line structure. If you are using the COMPONENT VIDEO OUT/ PROGRESSIVE SCAN jacks, but are connecting the DVD Player to a standard (analog) television, set Progressive Scan to Off.
If you are using the Component Video jacks for connection to a TV or monitor that is compatible with a progressive scan signal, set Progressive Scan to On.

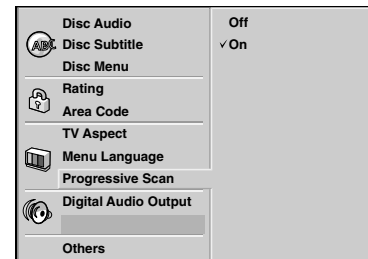

Notes

- Progressive Scan is available only when the VIDEO OUTPUT switch on the rear panel is set to COMPONENT/PROGRESSIVE SCAN.

Caution

Once the setting for progressive scan output is entered, an image will only be visible on a progressive scan compatible TV or monitor. If you set Progressive Scan to On in error, you must reset the unit. Pointing the remote at the player, press the STOP key to stop any disc that is playing. Next, press the STOP key again and hold it for five seconds before releasing it. The video output will be restored to the standard setting, and a picture will once again be visible on a conventional analog TV or monitor.

Before Operation (Cont'd)

Sound

Digital Audio Output

Each DVD disc may have a variety of audio output options. Set the player's Digital Audio Output according to the type of audio system you use.

DOLBY DIGITAL/PCM: Select "DOLBY DIGITAL/PCM" if you connect the DVD Player's DIGITAL OUT jack to a Dolby Digital decoder (or an amplifier or other equipment with a Dolby Digital decoder).

Stream/PCM: Select "Stream/PCM" if you connect the DVD Player's DIGITAL OUT jack to an amplifier or other equipment with a DTS decoder, Dolby Digital decoder or MPEG decoder.

PCM: Select when connected to a 2 channel digital stereo amplifier. The DVD player outputs sounds in the PCM 2ch format when you play a DVD video disc recorded on the Dolby Digital, MPEG1 or MPEG2 recording system.



Sample Frequency

To change the Sample Frequency setting, first select the desired Digital Audio Output as indicated above. If your receiver or amplifier is NOT capable of handling 96KHz signals, select 48KHz. When this choice is made, this unit will automatically convert any 96KHz signals to 48KHz so your system can decode them. If your receiver or amplifier is capable of handling 96KHz signals, select 96KHz. When this choice is made, this unit will pass all signals through without down conversion, or processing.

Others

The DRC, Vocal, PBC, B.L.E., Pluge and DNR settings can be changed.

- Press ▲/▼ to select the desired item and press ENTER. The setting of the selected item alternates between On and Off.



Dynamic Range Control (DRC)

With the DVD format, you can hear a program's soundtrack in the most accurate and realistic presentation possible, thanks to digital audio technology. However, you may wish to compress the dynamic range of the audio output (the difference between the loudest sounds and the quietest ones). Then, you may listen to a movie at a lower volume without losing clarity of sound. Set DRC to On for this effect.

Vocal

Set Vocal to On only when a multi-channel karaoke DVD is playing. The karaoke channels on the disc will mix into normal stereo sound.

PBC

Set Playback Control (PBC) to On or Off.

On: Video CDs with PBC are played according to the PBC.
Off: Video CDs with PBC are played the same way as Audio CDs.

B.L.E. (Black Level Expansion)

To select the black level of playback pictures. Set your preference and monitor's ability.

On: Expanded grey scale. (0 IRE cut off)
Off: Standard grey scale. (7.5 IRE cut off)

Pluge (Blacker than Black)

For proper adjustment of your television brightness settings utilizing a commercially available test disc.

On: Select when you adjust the level of your TV using a commercially available test disc that contains pluge signals.
Off: For normal use.

DNR (Digital Noise Reduction)

You can reduce ambient noise in the picture.

DNR1: Normal level
DNR2: Expanded level.
Off: Off.

Notes

- Actual picture enhancement may vary depending on the quality of the disc.
- While the DNR2 (expanded level) can provide additional improvement in the reduction of noise in the video signal, it may produce undesirable picture artifacts on some discs. Should this occur, select a more appropriate DNR level (normal or off).
- Depending on the disc, some picture detail may be lost by the picture enhancement.
- A DVD audio disc with Dolby Digital or DTS soundtrack may be played, some DVD audio discs include moving pictures which may be modified by the above processes.

Before Operation (Cont'd)

Parental Control

Rating **DVD**

Movies on DVDs may contain scenes not suitable for children. Therefore, discs may contain Parental Control information that applies to the complete disc or to certain scenes on the disc. These scenes are rated from 1 to 8, and alternatively, more suitable scenes are available for selection on some discs. Ratings are country-dependent. The Parental Control feature allows you to prevent discs from being played by your children or to have certain discs played with alternative scenes.

Disc Audio	8
Disc Subtitle	7
Disc Menu	6
Rating	5
Area Code	4
TV Aspect	3
Menu Language	2
Progressive Scan	1
Digital Audio Output	▶Unlock Change
Others	

- 1 Select "Rating" on the Setup menu using the ▲ and ▼ buttons.
- 2 While "Rating" is displayed, press ▶.
- 3 When you have not entered a password yet; Install a 4-digit password using the number buttons to create a personal 4-digit security password, then press ENTER. Enter the 4-digit password again and press ENTER to verify.
When you have already entered a password; Install your 4-digit password using the number buttons to confirm the personal 4-digit security password, then press ENTER.

If you make a mistake before pressing ENTER, press CLEAR and install your 4-digit security password again.
- 4 Select a rating from 1 to 8 using the ▲/▼ buttons. One (1) has the least playback restrictions. Eight (8) has the most playback restrictions.
Unlock: If you select Unlock, Parental Control is not active. The disc will play without restrictions.
Ratings 1 to 8: Some discs contain scenes not suitable for children. If you set a rating for the player, all disc scenes with the same rating or lower will be played. Higher rated scenes will not be played unless an alternative scene is available on the disc. The alternative must have the same rating or a lower one. If no suitable alternative is found, playback will stop. You must enter your 4-digit password or change the rating level in order to play the disc.
- 5 Press ENTER to confirm your rating selection, then press SETUP to exit the menu.

Area Code **DVD**

Enter the code of a country/area whose standards were used to rate the DVD video disc, referring to the list (See "Area Code List", page 27.).

Disc Audio	Code Set
Disc Subtitle	U S
Disc Menu	
Rating	
Area Code	
TV Aspect	
Menu Language	
Progressive Scan	
Digital Audio Output	
Others	

- 1 Select Area Code using the ▲/▼ buttons on the setup menu.
- 2 While Area Code is selected, press ▶.
- 3 Follow step 3 of "Rating" on left.
- 4 Select the first character using the ▲/▼ buttons.
- 5 Shift the cursor using ◀▶ buttons and select the second character using ▲/▼ buttons.
- 6 Press ENTER to confirm your area code selection, then press SETUP to exit the menu.

N Note

Confirmation of your 4-digit password is necessary when the password is changed (see "Changing the 4-digit password" below).

Changing the 4-digit password

- 1 Follow Steps 1-2 as shown above to the left (Rating).
- 2 Install your old code, then press ENTER.
- 3 Select Change using the ▲/▼ buttons then press ENTER.
- 4 Install the new 4-digit password, then press ENTER.
- 5 Install exactly the same code a second time and verify by pressing ENTER.
- 6 Press SETUP to exit the menu.

If you forget your 4-digit password

If you forget your password, to clear the current password, follow the procedure below.

- 1 Press SETUP to display the setup menu.
- 2 Use the Number buttons to enter the 6-digit number "210499."
The 4-digit password is cleared.
- 3 Enter a new code as shown above to the left (Rating).

Operation with DVD, Video CD and Audio CD

Playing a DVD, Video CD and Audio CD

T Playback Setup **DVD** **VCD2.0** **VCD1.1** **CD**

- Turn on the TV and select the video input source corresponding to the DVD player.
- Audio system: Turn on the audio system and select the input source connected to the DVD player.

1 Press OPEN/CLOSE to open the disc tray.

2 Load your disc in the center position, with the label facing up.

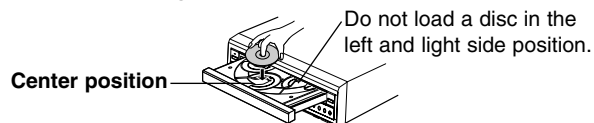

When a double-sided DVD is inserted, make sure the side you want to play is facing up.

- Discs can be loaded one at a time by pressing DISC SKIP to rotate the carousel.

3 Press OPEN/CLOSE to close the tray.

READING appears on the TV screen, and playback starts automatically. If playback does not start, press PLAY.

In some cases, the disc menu may appear instead.

T If a disc menu screen is displayed

The menu screen may be displayed first after loading a DVD or Video CD that contains a menu.

DVD

Use the ◀ ▶ ▲ ▼ buttons to select the title/chapter and additional selections you want, then press ENTER to start playback.

Press TOP MENU or MENU to return to the disc menu screen.

VCD2.0

- Use the number buttons to select the track you want to view.
Press RETURN to return to the disc menu screen.
- Menu setting and the exact operating procedures for using the disc menu may differ depending on the disc. Follow the instructions on each menu screen.
You also may set PBC to Off under setup. See page 14.

N Notes

- If Parental Control is set and the disc is not within the Rating settings (not authorized), the 4-digit password must be entered and/or the disc must be authorized (see “Parental Control”, on page 15).
- DVDs may have a region code.
- Your player will not play discs that have a region code different from your player. The region code for this player is 1 (one).

Exchanging discs during playback

- Press DISC CHANGE on the front panel during playback to open the disc tray.
- Press DISC SKIP to rotate the disc trays to the desired position. The carousel will rotate clockwise by one disc increments.
- Exchange the discs and press DISC CHANGE or OPEN/CLOSE to close the disc tray.

N Note

- The disc tray presently loaded in the play position can not be exchanged.

Skipping discs

Press DISC SKIP during play or when playback is stopped.

N Notes

- When DISC SKIP is pressed, the disc tray rotates and playback begins from the beginning of the next disc.
- If there is no disc on the next disc tray, the following disc tray will be selected.
- When DISC SKIP is pressed during playback of disc 5, playback of disc 1 will start.

Exchanging the disc and starting playback

1. Press OPEN/CLOSE during playback or when playback is stopped.
Play stops (if pressed during playback), the disc tray opens and the disc that was in the play position comes to the front.
2. Exchange the disc.
3. Press OPEN/CLOSE or PLAY again.
The tray closes and playback begins (with the disc that was in front).

Operation with DVD, Video CD and Audio CD (Cont'd)

General Features

Note

Unless stated otherwise, all operations described use the remote control. Some features may also be available from the Setup menu.

Moving to another TITLE 1/3





When a disc has more than one title, you can select to another title as follows:

- Press GUI DISPLAY when playback is stopped. From the title function, press the appropriate numbered button (0-9) to select a title number.

Moving to another CHAPTER/TRACK

    1/12  1/3

When a title on a disc has more than one chapter or a disc has more than one track, you can move to another chapter/track as follows:

- Press SKIP  or  briefly during playback to select the next chapter/track or to return to the beginning of the current chapter/track.
- Press  twice briefly to step back to the previous chapter/track.
- To go directly to any chapter during DVD playback, press GUI DISPLAY. Then, press / to select C (chapter) (or for a Video CD and Audio CD, select T for track). Then, enter the chapter/track number using the numbered buttons (0-9).

Note

For two-digit numbers, press the buttons in rapid succession.

Still Picture and Frame-by-frame playback













  

- 1 Press PAUSE/STEP during playback. The player will now go into PAUSE mode.
- 2 You can advance the picture frame by frame by pressing PAUSE/STEP repeatedly on the remote control.

Pause

- 1 Press PAUSE/STEP during playback.
- 2 To return to playback, press PLAY or press PAUSE/STEP again.



















Slow Motion

- 1 Press SLOW  or  during playback. The player will enter SLOW mode.
- 2 Use the SLOW  or  to select the required speed:  1/16,  1/8,  1/4 or  1/2 (reverse), or  1/16,  1/8,  1/4 or  1/2 (forward).
- 3 To exit slow motion mode, press PLAY.

Note

Slow motion playback in reverse is not available from a Video CD.



Search

- 1 Press REV  or FWD  during playback. The player will now go into SEARCH mode.
- 2 Press REV  or FWD  repeatedly to select the required speed: X2, X4, X16, X100 (backward) or X2, X4, X16, X100 (forward).
With a Video CD and Audio CD, the Search speed changes: X2, X4, X8 (backward) or X2, X4, X8 (forward).
- 3 To exit SEARCH mode, press PLAY.

Random

- 1 Press RANDOM during playback or in stop mode. The unit automatically begins Random Playback and "RANDOM (1-3)" appears on the TV screen.
 - RANDOM1: Plays all the tracks on a single disc in random order and then stops.
 - RANDOM2: Plays all the tracks on current disc in random order and then plays all the tracks on each succeeding disc in random order and then stops.
 - RANDOM3: Plays 2 tracks randomly from a disc and then plays 2 tracks randomly from a different disc until all tracks on all discs have been played.
- 2 To return to normal playback, press RANDOM until "RANDOM" disappears on the display window.

Tip

By pressing SKIP  or  during Random playback, the unit selects another title (track) and resumes Random playback.

Note

This function works only with Compact Discs, Karaoke discs and video CD without PBC.

Operation with DVD, Video CD and Audio CD (Cont'd)

General Features (cont'd)

Repeat **DVD** **VCD2.0** **VCD1.1** **CD**



DVD Video Discs - Repeat Chapter/Title/Off

- 1 To repeat the chapter currently playing, press REPEAT. The Repeat Chapter icon appears on the TV screen.
- 2 To repeat the title currently playing, press REPEAT two times. The Repeat Title icon appears on the TV screen.
- 3 To cancel Repeat mode, press REPEAT repeatedly until the Repeat Off icon appears on the TV screen.

Video CDs and Audio CDs - Repeat Track/Disc/All/Off

- 1 To repeat the track currently playing, press REPEAT. The Repeat Track icon appears on the TV screen.
- 2 To repeat the disc currently playing, press REPEAT two times. The Repeat Disc icon appears on the TV screen.
- 3 To Repeat of entire all disc contents, press REPEAT three times. The Repeat All icon appears on the TV screen.
- 4 To cancel Repeat mode, press REPEAT repeatedly until the Repeat Off icon appears on the TV screen.



Note

- On a Video CD with PBC, you must set PBC to Off on the setup menu to use the Repeat function. See page 14.
- If you press SKIP twice or SKIP during Repeat Chapter/Track playback, the repeat playback cancels.

Repeat A-B **DVD** **VCD2.0** **VCD1.1** **CD**



To repeat a sequence in a title:

- 1 Press A-B RPT at your chosen starting point. A- appears briefly on the TV screen.
- 2 Press A-B RPT again at your chosen end point. A-B appears briefly on the TV screen, and the repeat sequence begins (a-b repeat appears on the player's display).
- 3 To cancel the sequence, press A-B RPT.



Note

If you press SKIP or during repeat A-B, the A-B sequence are cleared.

Time Search **DVD** 0:16:57

The Time Search function allows you to start playing at any elapsed time location on the disc.

- 1 Press GUI DISPLAY during playback. The on-screen display appears on the screen. The Time Search box shows the elapsed playing time of the current disc.
- 2 Within 10 seconds, press / to select the Time Search icon in the on-screen display. The “-:--:--” appears in the Time Search box.
- 3 Within 10 seconds, use the number buttons to enter the required start time. Enter hours, minutes and seconds from left to right in the box. If you enter the wrong numbers, press CLEAR to remove the numbers you entered. Then enter the correct numbers.
- 4 Within 10 seconds, press ENTER to confirm the start time. Playback starts from the selected time on the disc. If you enter an invalid time, playback will continue from the current point.

Selecting the sound enhancement



Press E.A.M. to select the sound enhancement during playback.

NORM. : Normal sound

3D SUR: This player can produce a 3D Surround effect, which simulates multi-channel audio playback from two conventional stereo speakers, instead of the five or more speakers normally required to listen to multi-channel audio from a home theater system.

DIALOGUE: Enhances critical center channel information to make dialogue more intelligible (only when playing a DVD video disc recorded on the Dolby Digital recording system).

- To use this enhancement on audio output from the DIGITAL AUDIO OUT jack, be sure to set “Digital Audio Output” to “PCM”. See page 14.

Zoom **DVD** **VCD2.0** **VCD1.1**

The Zoom function allows you to expand the video image and to move the focus point of zoomed image.

- 1 Press ZOOM during playback or still playback to activate the Zoom function. If you press ZOOM repeatedly, the magnification level increases up to six times.
- 2 Use the /// buttons to move the focus point off the zoomed image.
- 3 Press CLEAR to resume normal playback or return to the paused image.



Notes

- The zoom function may not work for some DVDs.
- The zoom function may not work on multi-angle scenes.

General Features (cont'd)

Marker Search **DVD** **VCD2.0** **VCD1.1** **CD**



You can start playback from a memorized point. Up to nine points can be memorized.

To enter a mark, follow these steps.

- 1 During disc playback, press **MARKER** at the location you want to memorize.
The Marker icon will appear on the TV screen briefly.
- 2 Repeat step 1 to enter up to nine Marker points on a disc.

To Recall a Marked Scene

- 1 During disc playback, press **SEARCH**.
The **MARKER SEARCH** menu will appear on the screen.
- 2 Within 10 seconds, press **◀▶** to select a Marker number that you want to recall.
- 3 Press **ENTER**.
Playback will start from the Marked scene.
- 4 To remove the **MARKER SEARCH** menu, press **SEARCH**.

To clear a Marked Scene

- 1 During disc playback, press **SEARCH**.
The **MARKER SEARCH** menu will appear on the screen.
- 2 Press **◀▶** to select the Marker number that you want to erase.
- 3 Press **CLEAR**.
The Marker number will be erased from the list.
- 4 Repeat steps 2 and 3 to erase additional Marker numbers.
- 5 To remove the **MARKER SEARCH** menu, press **SEARCH**.

Note

All disc markers are cleared when the power is turned off, the disc is removed, or **DISC SKIP** button is pressed.

Special DVD Features **DVD**

Checking the contents of DVD Video discs: Menus

DVDs may contain menus that allow you to access special features. To access the disc menu, press **MENU**. Then, press the appropriate number button to select an option. Or, use the **◀▶/▲/▼** buttons to highlight your selection, then press **ENTER**.

Title Menu **DVD**

- 1 Press **TOP MENU**.
If the current title has a menu, that menu will appear on the screen. Otherwise, the disc menu may appear.
- 2 The menu can list camera angles, spoken language and subtitle options, and chapters for the title.
- 3 To remove the title menu, press **TOP MENU** again.

Disc Menu **DVD**

- 1 Press **MENU**.
The disc menu is displayed.
- 2 To exit the disc menu, press **MENU** again.

Camera Angle **DVD** 1/1

If the disc contains scenes recorded at different camera angles, you can change to a different camera angle during playback.

- Press **ANGLE** repeatedly during playback to select a desired angle.
The number of the current angle appears on the display.

Changing the Audio Language **DVD**



Press **AUDIO** repeatedly during playback to hear different audio languages or audio tracks available on the disc.

Changing the Audio Channel



Press **AUDIO** repeatedly during playback to hear a different audio channel (**STEREO**, **LEFT** or **RIGHT**).

Subtitles **DVD** 1 ENG

Press **SUBTITLE** repeatedly during playback to view the different subtitle languages available on the disc.

Note

If  appears, the feature is not available on the disc.

Programmed Playback with Video CD and Audio CD

Programmed Playback with Video CD and Audio CD

Note

On a Video CD with PBC, you must set PBC to Off on the setup menu to use the Program function. See page 14.

- 1 Insert a Video CD or Audio CD and close the tray.**
- 2 Press PROGRAM while playback is stopped.**
The Program menu will appear.

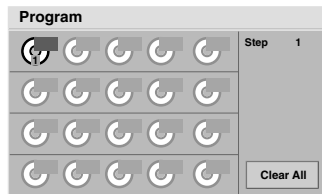

Note



Press PROGRAM or RETURN to exit the Program menu.

- 3 Enter the disc number using the numerical keys (1-5) and then press ENTER.**
- 4 Enter the track number using the numerical keys (0-9) and then press ENTER.**
The next area is selected.
- 5 Repeat steps 3 to 4.**
Up to 20 tracks can be programmed.
- 6 Press PLAY to exit the menu.**
The selected tracks are stored in the player memory and playback begins with the first programmed sequence.
- 7 After playback of all programmed tracks is completed, playback is stopped**

Repeat Programmed Tracks/All

- To repeat the track currently playing, press REPEAT. The Repeat Track icon appears on the TV screen.
- To repeat all tracks on the program list, press REPEAT two times. The Repeat All icon appears on the TV screen.
- To cancel Repeat mode, press REPEAT repeatedly until the Repeat Off icon appears on the TV screen.





Note

If you press SKIP  twice or SKIP  during Repeat Track playback, the repeat playback cancels.





To resume normal playback from programmed playback

Press PROGRAM until "PROG." indicator disappears in the display window.

Erasing a Track from Program List

- Press PROGRAM while playback is stopped. The Program menu will appear.
- Use / / /  to select the track that you wish to erase from the Program list.
- Press CLEAR. The track will be erased from the Program list.

Erasing the Complete Program List

- Press PROGRAM while playback is stopped. The Program menu will appear.
- Use / / /  to select "Clear All", then press ENTER. The complete Program for the disc will be erased. The programs are also cleared when the disc is removed.

Operation with MP3 Disc

Playing an MP3 disc **MP3**

The DVD Player can play MP3 formatted recordings on CD-ROM, CD-R or CD-RW discs.

Before playing MP3 recordings, read the notes on MP3 Recordings on right.

1 Insert a disc and close the tray.

The MP3/JPEG choice menu appears on the TV screen.



2 Press ▲/▼ to select the MP3 then press ENTER.

The MP3 menu appears on the TV screen.

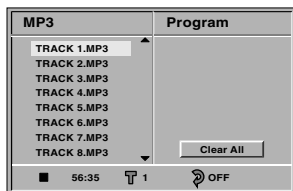

MP3 menu

3 Press ▲/▼ to select a track then press PLAY.

Playback starts.

During playback, the current track's elapsed playing time will appear on the display.

Playback will stop at the end of the disc.

Press TOP MENU to move to the next page.

Press MENU to move to the previous page.

4 To stop playback at any other time, press STOP.

Pause **MP3**

1 Press PAUSE/STEP during playback.

2 To return to playback, press PLAY or press PAUSE/STEP again.

Moving to another Track **MP3**

● Press SKIP ◀◀ or ▶▶ once during playback to advance to the next track or to return to the beginning of the current track.

● Press SKIP ◀◀ twice briefly to step back to the previous track.

Repeat Track/All/Off **MP3**

1 To repeat the track currently playing, press REPEAT.

The Repeat Track icon appears on the menu screen.

2 To repeat all tracks on a disc, press REPEAT two times.

The Repeat All icon appears on the menu screen.

3 To cancel Repeat mode, press REPEAT repeatedly until the Repeat Off icon appears on the menu screen.

Note

- The REPEAT button is not available when the [E] mark appear. Press PROGRAM to disappear the [E] mark.
- If you press SKIP ◀◀ twice or SKIP ▶▶ during Repeat Track playback, the repeat playback cancels.

Notes on MP3 Discs

About MP3

- An MP3 file is audio data compressed by using the MPEG1 audio layer-3 file-coding scheme. We call files that have the ".mp3" file extension "MP3 files".
- The player can not read an MP3 file that has a file extension other than ".mp3".
- The player can not read a non MP3 encoded file that has a file extension ".mp3".

MP3 Disc compatibility with this player is limited as follows:

1. Sampling Frequency / only at 44.1kHz
2. Bit rate / within 32 - 320kbps
3. CD-R physical format should be "ISO 9660"
4. If you record MP3 files using the software which cannot create a FILE SYSTEM, for example "Direct-CD" etc., it is impossible to playback MP3 files. We recommend that you use "Easy-CD Creator", which creates an ISO9660 file system.
5. A single session disc requires MP3 files in the first track. If there is no MP3 file in the 1st track, it cannot playback MP3 files. If you wish to playback MP3 files, format all the data in the disc or use a new one.
6. We do not recommend using CD-RW discs. Please use finished CD-R discs only.
7. File names should be named using 8 letters or less and must incorporate ".mp3" extension e.g. "*****.MP3".
8. Do not use special letters such as "_?!><+*}{[@];:;V." etc.
9. Total number of files on the disc should be less than 200.
10. Use 74 minute CD-R discs (650M), Do not use 80 minute CD-R (700M) software

This DVD player requires discs/recordings to meet certain technical standards in order to achieve optimal playback quality. Pre-recorded DVDs are automatically set to these standards. There are many different types of recordable disc formats (including CD-R containing MP3 files). That require certain pre-existing conditions (see above) to insure compatible playback.

Customers should also note that permission is required in order to download MP3 files and music from the Internet. TOSHIBA cannot grant such permission. Permission should always be sought from the copyright owner.

Operation with JPEG Disc

Viewing a JPEG disc **JPEG**

This DVD Player can play discs with JPEG files on it. Make sure the resolution of the JPEG files is less than 2 mega pixels (2M).

Notes

- Depending upon the size and number of the JPEG files, it could take a long time for the DVD player to read the disc's contents. If you don't see an on-screen display after several minutes, some of the files are too big — reduce the resolution of the JPEG files to less than 2 mega pixels and burn another disc.
- Total number of files on the disc should be less than 200.
- Some disc may be incompatible due to different recording format or condition of disc.

1 Insert a disc and close the tray.

The MP3/JPEG choice menu appears on the TV screen.



2 Press ▲/▼ to select the JPEG then press ENTER.

The JPEG menu appears on the TV screen. Press RETURN to move to the previous menu (MP3/JPEG choice menu).

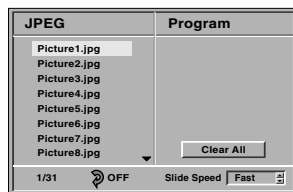

JPEG menu

3 If you want to view a particular file, press ▲/▼ to highlight a file and press ENTER or PLAY.

Viewing the file proceeding starts. During viewing a file, press GUI DISPLAY or RETURN to move to the previous menu (JPEG menu).

Press TOP MENU to move to the next page.
Press MENU to move to the previous page.

Tip

There are three viewing Slide Speed options: Fast, Normal, and Slow. Press ◀▶ to highlight the Slide Speed then press ▲/▼ to select the option you want to use, and press ENTER.

4 To stop viewing at any other time, press STOP.

The JPEG menu appears.

Moving to another File

- Press SKIP ◀◀ or ▶▶ once during viewing to advance to the next file or to the previous file.

Repeat All/Off

- 1 To repeat all files on a disc, press REPEAT when JPEG menu appears.

The Repeat All icon appears on the menu screen.

- 2 Press PLAY or ENTER to start repeat playback.

- 3 To cancel Repeat mode, first press STOP to stop playback then press REPEAT when JPEG menu appears.

The Repeat Off icon appears on the menu screen.

Note

The REPEAT button is not available when the [E] mark appear. Press PROGRAM to disappear the [E] mark.

Programmed Playback with MP3 or JPEG Disc

Programmed Playback with MP3 or JPEG Disc

MP3 **JPEG**

Program allows you to store your favorite tracks/files (or files) for a particular disc in the player memory.

Program can contain 60 tracks/files.

- 1 Insert a disc and close the tray.**
The MP3/JPEG choice menu appears on the TV screen.



- 2 Press ▲/▼ to select the MP3 or JPEG then press ENTER.**

The MP3 or JPEG menu appears on the TV screen. Press RETURN to move to the previous menu (MP3/JPEG choice menu).

- 3 Press PROGRAM in the stop mode or during playback (MP3 only) to enter the Program Edit mode.**

The  mark will appear to the right of the word Program on the right side of the menu screen.

Note

Press PROGRAM to exit the Program Edit mode; the  mark will disappear.

- 4 Press ▲/▼ to select a track/file then press ENTER to place the selected track/file on the Program list.**

- 5 Repeat step 4 to place additional tracks/files on the Program list.**

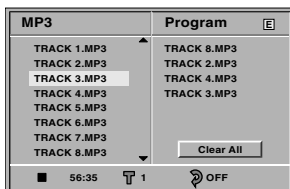

MP3 menu

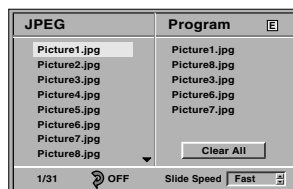

JPEG menu

- 6 Press ►.**
The programmed track/file you selected last is highlighted on the program list.

- 7 Press ▲/▼ to select the track/file you want to start playing.**

Press TOP MENU to move to the next page.
Press MENU to move to the previous page.

- 8 Press ENTER or PLAY to start.**

Playback begins in the order in which you programmed the tracks/files and "PROG." appears in the display window. Playback stops after playing the last programmed track/file on the program list.

Note



The programmed tracks/files are cleared when the power is turned off or the disc is removed.

Repeat Programmed Tracks/All/Off

MP3

- To repeat the track currently playing, press REPEAT.
The Repeat Track icon appears on the menu screen.
- To repeat all tracks on the program list, press REPEAT two times.
The Repeat All icon appears on the menu screen.
- To cancel Repeat mode, press REPEAT repeatedly until the Repeat Off icon appears on the menu screen.

Note



If you press SKIP  twice or SKIP  during Repeat Track playback, the repeat playback cancels.

Repeat Programmed All/Off

JPEG

- To repeat all files on the program list, press REPEAT when JPEG menu appears.
The Repeat All icon appears on the menu screen.
- Press PLAY or ENTER to start repeat playback.
- To cancel Repeat mode, first press STOP to stop playback then press REPEAT when JPEG menu appears.

Note

The REPEAT button is not available when the  mark appear. Press PROGRAM to disappear the  mark.

Erasing a Track/File from Program List

- Press PROGRAM during playback or in the stop mode to enter the Program Edit mode.
The  mark will appear.

Note

JPEG can be programmed only in stop mode (when menu screen is displayed.)

- Press ► to move to the Program list.
- Use ▲/▼ to select the track/file that you wish to erase from the Program list.
- Press CLEAR.
The track/file will be erased from the Program list.

Erasing the Complete Program List

- Follow steps 1-2 of "Erasing a Track/File from Program List" as above.
- Use ▲/▼ to select "Clear All", then press ENTER.
The complete Program for the disc will be erased.
The programs are also cleared when the disc is removed.

To resume normal playback from programmed playback

Press and hold PROGRAM for 3 seconds until "PROG." indicator disappears in the display window.

Additional Information

Last Condition Memory

DVD **CD** **VCD1.1**

This player memorizes the last condition for the last disc you have watched. Settings remain in memory even if you remove the disc from the player or switch off the player. If you load a disc that has its settings memorized, the latest stop position is automatically recalled.

Notes

- Settings are stored in memory for use any time.
- This player does not memorize settings of a disc if you switch off the player before commencing playback.

Screen Saver

A screen saver image appears when you leave the DVD Player in stop mode for about five minutes.

After the Screen Saver has been engaged for about five minutes, the DVD Player will automatically turn itself off.

Video Mode Setting **DVD** **VCD2.0** **VCD1.1**

- With certain discs, the playback picture may be flickering or Dot Crawl is shown on straight lines. That means Vertical interpolation or De-interlace is not perfectly matched with the disc. In this case, the picture quality may be improved by changing the video mode.
- To change the video mode, press and hold GUI DISPLAY about 3 seconds during disc playback. The new video mode number selected is displayed on the TV screen. Check whether the video quality has improved. If not, repeat the above procedure until picture quality is improved.
- Video mode sequence:
Video1 → Video2 → Film → Adapt → Auto.
- If you turn off the power, the video mode will return to initial default state (Auto).

Detailed Description of each Video Mode

Auto : The source material of the DVD video (film material or video material) is determined from disc information.

Video1 : Suitable for playing video based content with comparatively little motion.

Video2 : Suitable for playing video based content with comparatively more motion.

Film : Suitable for playing film based content or video based material recorded by the progressive scan method.

Adapt : Determines the appropriate mode (film or video) during disc playback, and automatically selects the proper mode. Suitable for playing a disc comprised of film and video based content.

Troubleshooting

Check the following guide for the possible cause of a problem before contacting service.

Symptom	Cause	Correction
No power.	<ul style="list-style-type: none"> The power cord is disconnected. 	<ul style="list-style-type: none"> Plug the power cord into the wall outlet securely.
The power is on, but the DVD player does not work.	<ul style="list-style-type: none"> No disc is inserted. 	<ul style="list-style-type: none"> Insert a disc. (Check that the DVD or, audio CD indicator in the display window is lit.)
No picture.	<ul style="list-style-type: none"> The TV is not set to receive DVD signal output. 	<ul style="list-style-type: none"> Select the appropriate video input mode on the TV so the picture from the DVD player appears on the TV screen.
	<ul style="list-style-type: none"> The video cable is not connected securely. 	<ul style="list-style-type: none"> Connect the video cable into the jacks securely.
	<ul style="list-style-type: none"> The connected TV power is turned off. 	<ul style="list-style-type: none"> Turn on the TV.
No sound.	<ul style="list-style-type: none"> The equipment connected with the audio cable is not set to receive DVD signal output. 	<ul style="list-style-type: none"> Select the correct input mode of the audio receiver so you can listen to the sound from the DVD player.
	<ul style="list-style-type: none"> The audio cables are not connected securely. 	<ul style="list-style-type: none"> Connect the audio cable into the jacks securely.
	<ul style="list-style-type: none"> The power of the equipment connected with the audio cable is turned off. 	<ul style="list-style-type: none"> Turn on the equipment connected with the audio cable.
	<ul style="list-style-type: none"> The Digital Audio Output is set to the wrong position. 	<ul style="list-style-type: none"> Set the Digital Audio Output to the correct position, then turn on the DVD player again by pressing POWER.
The playback picture is poor.	<ul style="list-style-type: none"> The disc is dirty. 	<ul style="list-style-type: none"> Clean the disc.
The DVD player does not start playback.	<ul style="list-style-type: none"> No disc is inserted. 	<ul style="list-style-type: none"> Insert a disc. (Check that the DVD, or audio CD indicator in the DVD display is lit.)
	<ul style="list-style-type: none"> An unplayable disc is inserted. 	<ul style="list-style-type: none"> Insert a playable disc. (Check the disc type, color system and Regional code.)
	<ul style="list-style-type: none"> The disc is placed upside down. 	<ul style="list-style-type: none"> Place the disc with the playback side down.
	<ul style="list-style-type: none"> The disc is not placed within the guide. 	<ul style="list-style-type: none"> Place the disc on the disc tray correctly inside the guide.
	<ul style="list-style-type: none"> The disc is dirty. 	<ul style="list-style-type: none"> Clean the disc.
	<ul style="list-style-type: none"> The Rating level is set. 	<ul style="list-style-type: none"> Cancel the Rating function or change the rating level.
The remote control does not work properly.	<ul style="list-style-type: none"> The remote control is not pointed at the remote sensor of the DVD player. 	<ul style="list-style-type: none"> Point the remote control at the remote sensor of the DVD player.
	<ul style="list-style-type: none"> The remote control is too far from the DVD player. 	<ul style="list-style-type: none"> Operate the remote control within about 23 ft (7 m).
	<ul style="list-style-type: none"> There is an obstacle in the path of the remote control and the DVD player. 	<ul style="list-style-type: none"> Remove the obstacle.
	<ul style="list-style-type: none"> The batteries in the remote control are exhausted. 	<ul style="list-style-type: none"> Replace the batteries with new ones.

Language Code List

Enter the appropriate code number for the initial settings “Disc Audio”, “Disc Subtitle” and/or “Disc Menu” (See page 13).

Code	Language	Code	Language	Code	Language	Code	Language
6565	Afar	7079	Faroese	7678	Lingala	8375	Slovak
6566	Abkhazian	7082	French	7679	Laothian	8376	Slovenian
6570	Afrikaans	7089	Frisian	7684	Lithuanian	8377	Samoaan
6577	Ameharic	7165	Irish	7686	Latvian, Lettish	8378	Shona
6582	Arabic	7168	Scots Gaelic	7771	Malagasy	8379	Somali
6583	Assamese	7176	Galician	7773	Maori	8381	Albanian
6588	Aymara	7178	Guarani	7775	Macedonian	8382	Serbian
6590	Azerbaijani	7185	Gujarati	7776	Malayalam	8385	Sudanese
6665	Bashkir	7265	Hausa	7778	Mongolian	8386	Swedish
6669	Byelorussian	7273	Hindi	7779	Moldavian	8387	Swahili
6671	Bulgarian	7282	Croatian	7782	Marathi	8465	Tamil
6672	Bihari	7285	Hungarian	7783	Malay	8469	Telugu
6678	Bengali; Bangla	7289	Armenian	7784	Maltese	8471	Tajik
6679	Tibetan	7365	Interlingua	7789	Burmese	8472	Thai
6682	Breton	7378	Indonesian	7865	Nauru	8473	Tigrinya
6765	Catalan	7383	Icelandic	7869	Nepali	8475	Turkmen
6779	Corsican	7384	Italian	7876	Dutch	8476	Tagalog
6783	Czech	7387	Hebrew	7879	Norwegian	8479	Tonga
6789	Welsh	7465	Japanese	7982	Oriya	8482	Turkish
6865	Danish	7473	Yiddish	8065	Panjabi	8484	Tatar
6869	German	7487	Javanese	8076	Polish	8487	Twi
6890	Bhutani	7565	Georgian	8083	Pashto, Pushto	8575	Ukrainian
6976	Greek	7575	Kazakh	8084	Portuguese	8582	Urdu
6978	English	7576	Greenlandic	8185	Quechua	8590	Uzbek
6979	Esperanto	7577	Cambodian	8277	Rhaeto-Romance	8673	Vietnamese
6983	Spanish	7578	Kannada	8279	Rumanian	8679	Volapük
6984	Estonian	7579	Korean	8285	Russian	8779	Wolof
6985	Basque	7583	Kashmiri	8365	Sanskrit	8872	Xhosa
7065	Persian	7585	Kurdish	8368	Sindhi	8979	Yoruba
7073	Finnish	7589	Kirghiz	8372	Serbo-Croatian	9072	Chinese
7074	Fiji	7665	Latin	8373	Singhalese	9085	Zulu

Area Code List

Enter the appropriate code number for the initial setting "Area Code" (See page 15).

Code	Area	Code	Area	Code	Area	Code	Area
AD	Andorra	ER	Eritrea	LC	Saint Lucia	SC	Seychelles
AE	United Arab Emirates	ES	Spain	LI	Liechtenstein	SD	Sudan
AF	Afghanistan	ET	Ethiopia	LK	Sri Lanka	SE	Sweden
AG	Antigua and Barbuda	FI	Finland	LR	Liberia	SG	Singapore
AI	Anguilla	FJ	Fiji	LS	Lesotho	SH	Saint Helena
AL	Albania	FK	Falkland Islands	LT	Lithuania	SI	Slovenia
AM	Armenia	FM	Micronesia	LU	Luxembourg	SJ	Svalbard and Jan Mayen Islands
AN	Netherlands Antilles	FO	Faroe Islands	LV	Latvia	SK	Slovak Republic
AO	Angola	FR	France	LY	Libya	SL	Sierra Leone
AQ	Antarctica	FX	France (European Territory)	MA	Morocco	SM	San Marino
AR	Argentina	GA	Gabon	MC	Monaco	SN	Senegal
AS	American Samoa	GB	Great Britain	MD	Moldavia	SO	Somalia
AT	Austria	GD	Grenada	MG	Madagascar	SR	Suriname
AU	Australia	GE	Georgia	MH	Marshall Islands	ST	Saint Tome and Principe
AW	Aruba	GF	French Guyana	MK	Macedonia	SU	Former USSR
AZ	Azerbaijan	GH	Ghana	ML	Mali	SV	El Salvador
BA	Bosnia-Herzegovina	GI	Gibraltar	MM	Myanmar	SY	Syria
BB	Barbados	GL	Greenland	MN	Mongolia	SZ	Swaziland
BD	Bangladesh	GM	Gambia	MO	Macau	TC	Turks and Caicos Islands
BE	Belgium	GN	Guinea	MP	Northern Mariana Islands	TD	Chad
BF	Burkina Faso	GP	Guadeloupe (French)	MQ	Martinique (French)	TF	French Southern Territories
BG	Bulgaria	GQ	Equatorial Guinea	MR	Mauritania	TG	Togo
BH	Bahrain	GR	Greece	MS	Montserrat	TH	Thailand
BI	Burundi	GS	S. Georgia & S. Sandwich Isls.	MT	Malta	TJ	Tadjikistan
BJ	Benin	GT	Guatemala	MU	Mauritius	TK	Tokelau
BM	Bermuda	GU	Guam (USA)	MV	Maldives	TM	Turkmenistan
BN	Brunei Darussalam	GW	Guinea Bissau	MW	Malawi	TN	Tunisia
BO	Bolivia	GY	Guyana	MX	Mexico	TO	Tonga
BR	Brazil	HK	Hong Kong	MY	Malaysia	TP	East Timor
BS	Bahamas	HM	Heard and McDonald Islands	MZ	Mozambique	TR	Turkey
BT	Bhutan	HN	Honduras	NA	Namibia	TT	Trinidad and Tobago
BV	Bouvet Island	HR	Croatia	NC	New Caledonia (French)	TV	Tuvalu
BW	Botswana	HT	Haiti	NE	Niger	TW	Taiwan
BY	Belarus	HU	Hungary	NF	Norfolk Island	TZ	Tanzania
BZ	Belize	ID	Indonesia	NG	Nigeria	UA	Ukraine
CA	Canada	IE	Ireland	NI	Nicaragua	UG	Uganda
CC	Cocos (Keeling) Islands	IL	Israel	NL	Netherlands	UK	United Kingdom
CF	Central African Republic	IN	India	NO	Norway	UM	USA Minor Outlying Islands
CG	Congo	IO	British Indian Ocean Territory	NP	Nepal	US	United States
CH	Switzerland	IQ	Iraq	NR	Nauru	UY	Uruguay
CI	Ivory Coast	IR	Iran	NU	Niue	UZ	Uzbekistan
CK	Cook Islands	IS	Iceland	NZ	New Zealand	VA	Vatican City State
CL	Chile	IT	Italy	OM	Oman	VC	Saint Vincent & Grenadines
CM	Cameroon	JM	Jamaica	PA	Panama	VE	Venezuela
CN	China	JO	Jordan	PE	Peru	VG	Virgin Islands (British)
CO	Colombia	JP	Japan	PF	Polynesia (French)	VI	Virgin Islands (USA)
CR	Costa Rica	KE	Kenya	PG	Papua New Guinea	VN	Vietnam
CS	Former Czechoslovakia	KG	Kyrgyzstan	PH	Philippines	VU	Vanuatu
CU	Cuba	KH	Cambodia	PK	Pakistan	WF	Wallis and Futuna Islands
CV	Cape Verde	KI	Kiribati	PL	Poland	WS	Samoa
CX	Christmas Island	KM	Comoros	PM	Saint Pierre and Miquelon	YE	Yemen
CY	Cyprus	KN	Saint Kitts & Nevis Anguilla	PN	Pitcairn Island	YT	Mayotte
CZ	Czech Republic	KP	North Korea	PR	Puerto Rico	YU	Yugoslavia
DE	Germany	KR	South Korea	PT	Portugal	ZA	South Africa
DJ	Djibouti	KW	Kuwait	PW	Palau	ZM	Zambia
DK	Denmark	KY	Cayman Islands	PY	Paraguay	ZR	Zaire
DM	Dominica	KZ	Kazakhstan	QA	Qatar	ZW	Zimbabwe
DO	Dominican Republic	LA	Laos	RE	Reunion (French)		
DZ	Algeria	LB	Lebanon	RO	Romania		
EC	Ecuador			RU	Russian Federation		
EE	Estonia			RW	Rwanda		
EG	Egypt			SA	Saudi Arabia		
EH	Western Sahara			SB	Solomon Islands		

Specifications

General

Power requirements	AC 120V , 60 Hz
Power consumption	14W
Dimensions (approx.)	430 X 79.9 X 410 mm (16.9 x 3.2 x 16.2 inches) (w x h x d)
Mass (approx.)	5.1 kg (12.3 lbs)
Operating temperature	5°C to 35°C (41°F to 95°F)
Operating humidity	5 % to 90 %

System

Laser	Semiconductor laser, wavelength 650 nm
Signal system	NTSC
Frequency response	DVD (PCM 96 kHz): 8 Hz to 44 kHz DVD (PCM 48 kHz): 8 Hz to 22 kHz CD: 8 Hz to 20 kHz
Signal-to-noise ratio	More than 100dB (ANALOG OUT connectors only)
Harmonic distortion	Less than 0.008%
Dynamic range	More than 100 dB (DVD) More than 95 dB (CD)

Outputs

VIDEO OUT	1 Vp-p 75 ohms, sync negative, RCA jack x 1
S-VIDEO OUT	(Y) 1.0 V (p-p), 75 Ω, negative sync., Mini DIN 4-pin x 1 (C) 0.3 V (p-p) 75 ohms
COMPONENT VIDEO OUT	(Y) 1.0 V (p-p), 75 Ω, negative sync., RCA jack x 1 (Pb)/(Pr) 0.7 V (p-p), 75 Ω, RCA jack x 2
Audio output (digital audio)	0.5 V (p-p), 75 Ω, RCA jack x 1
Audio output (optical audio)	5 V (p-p), 75 Ω, Optical connector x 1
Audio output (analog audio)	2.0 Vrms (1 KHz, 0 dB), 330 Ω, RCA jack (L, R) x 2

Accessory

Video cable	1
Audio cable	1
Remote control	1
Batteries	2

- Design and specifications are subject to change without notice.

Manufactured under license from Dolby Laboratories. "Dolby" and the double-D symbol are trademarks of Dolby Laboratories. Confidential unpublished works. Copyright 1992-1997 Dolby Laboratories. All rights reserved.

"DTS" and "DTS Digital Out" are trademarks of Digital Theater Systems, Inc.

LIMITED WARRANTY DVD VIDEO PLAYER

Toshiba America Consumer Products, Inc. ("TACP"), Toshiba Hawaii ("THI") and Toshiba Canada Limited ("TCL") make the following limited warranties. These limited warranties extend to original purchaser or any person receiving this set as a gift from the original purchaser and to no other purchaser or transferee.

Limited Ninety (90) Day Warranty

TACP/THI warrant this product against defects in materials or workmanship for a period of ninety (90) days after the date of original retail purchase. During this period, TACP/THI will repair or replace a defective product or part, at their option, with a new or refurbished product or part without charge to you. You must deliver the entire product to a TACP/THI Authorized Service Station. You are responsible for all transportation and insurance charges for the unit to and from the Authorized Service Station. If you live in the U.S.A. you may, at your option, return your DVD Unit to:

Toshiba America Consumer Products Inc.
Returns Center
1420C Toshiba Dr.
Lebanon, TN 37087

Upon receipt we will, at our option, exchange the DVD Unit with a new or refurbished unit. **Canadian consumers are requested to contact TCL. In Hawaii consumers are requested to contact THI.**

Limited One (1) Year Warranty

TACP/THI further warrant the parts in this product against defects in materials or workmanship for a period of one (1) year after the date of original retail purchase. During this period, TACP/THI will repair or replace a defective product or part, at their option, with a new or refurbished product or part without charge to you, except that if a defective part is replaced after ninety (90) days from the date of the original retail purchase you pay labor charges involved in the replacement. You must also deliver the entire product to a TACP/THI Authorized Service Station. You are responsible for all transportation and insurance charges for the unit to and from the Authorized Service Station. If you live in the U.S.A. you may, at your option, return your DVD Unit to:

Toshiba America Consumer Products Inc.
Returns Center
1420C Toshiba Dr.
Lebanon, TN 37087

Upon receipt we will, at our option, exchange the DVD Unit with a new or refurbished unit. **Canadian Consumers are requested to contact TCL. In Hawaii consumers are requested to contact THI.**

Rental Units

The warranty for rental units begin with the first rental or thirty (30) days from the date of shipment to the rental firm, whichever comes first.

Commercial Units

Products sold and used for commercial use have a limited ninety (90) day warranty for all parts and labor.

Owner's Manual

You should read the owner's manual thoroughly before operating this product. You should complete and mail the enclosed Demographic card within ten (10) days after you, or the person who has given you this product as a gift, purchased this product. This is one way to enable TACP to provide you with better customer service and improved products. Failure to return the card will not affect your rights under this warranty.

Your Responsibility

The above warranties are subject to the following conditions:

- (1) You must retain your bill of sale or provide other proof of purchase.
- (2) You must notify a TACP/THI/TCL /Authorized Service Station within thirty (30) days after you discover a defective product or part.
- (3) All warranty servicing of this product must be made by a TACP/THI/TCL Authorized Service Station.
- (4) U.S.A. warranties are effective only if the product is purchased and operated in the Continental U.S.A. or Puerto Rico.
- (5) Labor service charges for set installation. Set up, adjustment of customer controls and installation or repair of antenna systems are not covered by this warranty. Reception problems caused by inadequate antenna systems are your responsibility.
- (6) Warranties extend only to defects in materials or workmanship as limited above and do not extend to any product or parts which have been lost or discarded by you or to damage to products or parts caused by misuse, accident, damage caused by Acts of God, such as lightning or fluctuations in electric power, improper installation, improper maintenance or use in violation of instructions furnished by us; or to units which have been altered or modified without authorization of TACP/THI/TCL or to damage to products or part thereof which have had the serial number removed, altered, defaced or rendered illegible.
- (7) Should you elect to return your DVD Unit to TACP after the ninety (90) days and within one (1) year, or after the warranty period has expired: Call (800)-631-3811 to receive information concerning an exchange price. Payment must be enclosed with product in the form of a certified check or money order including reason for return.
- (8) Physically damaged DVD Units are not acceptable for repair or exchange whether in or out of warranty and will be returned as received.

OTHERS

(Continued)

LIMITED WARRANTY DVD VIDEO PLAYER (Continued)

How to Obtain Warranty Service

- (1) Refer to the troubleshooting guide in your owner's manual. This check list may solve your problem.
- (2) In the U.S.A., only call the TACP toll free number 800-631-3811, or if in Hawaii or Canada see listing below within (30) days after you find a defective product or part.
- (3) Arrange for the delivery of the product to the TACP/THI/TCL Authorized Service Station or TACP Return Center. Products shipped to the Service Station must be insured and safely and securely packed, preferably in the original shipping carton, and a letter explaining the defect and also a copy of the bill of sale or other proof of purchase must be enclosed.

In the Continental United States contact:



In Hawaii contact:

Toshiba Hawaii Inc.
327 Kamakee Street
Honolulu, HA 96814
(808)-521-5377

In Canada contact:

Consumer Electronics Group
191 McNabb Street
Markham, Ontario L3R 8H2
(905)-470-5400

Consumer Electronics Group
22171 Fraserwood Way
Richmond, B.C. V6W 1J5
(604)-303-2500

Consumer Electronics Group
1643 North Service Road
Droval, QC H9P 1J1
(514)-856-4100

All warranties implied by state law, including the implied warranties of merchantability and fitness for a particular purpose, are expressly limited to the duration of the limited warranties set forth above. With the exception of any warranties implied by state law as hereby limited, the foregoing warranty is exclusive and in lieu of all other warranties, guarantees, agreements and similar obligations of manufacturer or seller with respect to the repair or replacement of any parts. In no event shall TACP/THI be liable for consequential or incidental damages.

No person, agent, distributor, dealer or company is authorized to change, modify or extend the terms of these warranties in any manner whatsoever. The time within which an action must be commenced to enforce any obligation of TACP/THI arising under the warranty or under any statute, or law of the United States or any state thereof, is hereby limited to ninety (90) days from the date you discover or should have discovered, the defect. This limitation does not apply to implied warranties arising under state law. This warranty gives you specific legal rights and you may also have other rights which may vary from state to state. Some states do not allow limitation on how long an implied warranty lasts, when an action may be brought, or the exclusion or limitation of incidental or consequential damages, so the above provisions may not apply to you.

ATTENTION CANADIAN CONSUMERS:

Canadian consumers are requested to complete the special Canadian "Warranty Registration Form" enclosed, and forward this completed form with a copy of bill of sale to TOSHIBA OF CANADA to "Register and Validate" their warranty. Product must be purchased from an Authorized Canadian Dealer. Products purchased in the U.S.A. and used in Canada are not covered by these warranties.

IMPORTANT: PACKING AND SHIPPING INSTRUCTION

When you send the product to a Service Station, you must use the original carton box and packing material, then insert the original carton box containing the unit into another carton using more packing material.